

ECT_16B8C

Block User Guide

V01.06

Original Release Date: 2-Sep-1999
Revised: Jul 05, 2004

Motorola Inc.

Motorola reserves the right to make changes without further notice to any products herein to improve reliability, function or design. Motorola does not assume any liability arising out of the application or use of any product or circuit described herein; neither does it convey any license under its patent rights nor the rights of others. Motorola products are not designed, intended, or authorized for use as components in systems intended for surgical implant into the body, or other applications intended to support or sustain life, or for any other application in which the failure of the Motorola product could create a situation where personal injury or death may occur. Should Buyer purchase or use Motorola products for any such unintended or unauthorized application, Buyer shall indemnify and hold Motorola and its officers, employees, subsidiaries, affiliates, and distributors harmless against all claims, costs, damages, and expenses, and reasonable attorney fees arising out of, directly or indirectly, any claim of personal injury or death associated with such unintended or unauthorized use, even if such claim alleges that Motorola was negligent regarding the design or manufacture of the part.

Revision History

Version Number	Revision Date	Effective Date	Author	Description of Changes
0.1	2-Sep-99	2-Sep-99		Original draft. Distributed only within Motorola QS9000 Verified.
0.2	24-Sep-99	24-Sep-99		<ul style="list-style-type: none"> • Changed the specs as per MSRS format. • Modified ECT16b8c Block diagram. • Modified IP Bus signal names and their description. • Modified ECT output signal names. • Deleted bits 3-0 of TSCR1 register in Register Map(Sheet 1 of 2). • Modified register addresses in the description of TSFRZ, WAIT, NORMAL mode(Modes of Operation). • In Figure 1-6 changed text font to Halvetica. • Renamed TMSK1 and TMSK2 register as TIE and TSCR2 also renamed TSCR as TSCR1. • Modified TFLG2 bit setting sentence. • Added explanation about the abbreviation(M clock, PACLK) used. • Removed duplication of lines at the end of register description of PACN3/PACN2. • Corrected the reset value of MCCNT from \$FF to \$FFFF in the description of register MCCTL. • Corrected Table format for delay counter select and Modulus counter Prescalar Select. • Corrected all the cross-references used in section 3 of the document. • Deleted and added some module specific signals. • Changed all interrupts from active LOW to active HIGH. • Added description about successful output compare and forced output compare taking place simultaneously and their effect on flag. • Added abbreviation section. • In Fig 1-3 changed host data bus to IPbus.
0.3	25-Oct-99	25-Oct-99		<ul style="list-style-type: none"> • Changed block name in Section 2. • Removed signals ipp_ect_ic_ibe and ipp_ect_ic_offval from port list.
0.4	11-Nov-99	11-Nov-99		<ul style="list-style-type: none"> • Removed signal ipb_read & ipb_write from portlist. ipb_rwb added

Version Number	Revision Date	Effective Date	Author	Description of Changes
0.5	1-Dec-99	1-Dec-99		<ul style="list-style-type: none"> Incorporated feedback received from Joachim Kruecken on 30-Nov-99
01.00	10-May-01	11-May-01		<ul style="list-style-type: none"> formal changes for SRS compliance (cover, master pages, paragraph formats, register templates) updated cross-references marked TIMTST register description with 'non_cust' tag
01.01	19-July-01			<ul style="list-style-type: none"> Document names have been added Names and Variable definitions have been hidden
01.02	10-Jan-02	10-Jan-02		<ul style="list-style-type: none"> Note added in Section 3.3.18 for PACN1/PACN0
01.03	18-Jul-02	18-Jul-02		<ul style="list-style-type: none"> Changed the register bit information of MCCTL on bits ICLAT and FLMC
01.04	11-Nov-02	11-Nov-02		<ul style="list-style-type: none"> Eliminated all references of "n" to "x" .e.g. IOSn to IOSx
01.05	12-Mar-04	12-Mar-04		<ul style="list-style-type: none"> Description of OC7M and TCTL1 registers modified, note on OC added in section 4.
01.06	05-Jul-04	05-Jul-04		<ul style="list-style-type: none"> Included description about delay counter in section 4.2.1.3 Modified the description about TCNT in section 3. 3.5

Freescale Semiconductor, Inc.

Table of Contents

Section 1 Introduction

1.1	Overview	13
1.2	Features	13
1.3	Modes of Operation	13
1.4	Block Diagram	14

Section 2 Signal Description

2.1	Overview	15
2.2	Detailed Signal Descriptions	15
2.2.1	IOC7 - Input capture and Output compare channel 7	15
2.2.2	IOC6 - Input capture and Output compare channel 6	15
2.2.3	IOC5 - Input capture and Output compare channel 5	15
2.2.4	IOC4 - Input capture and Output compare channel 4	15
2.2.5	IOC3 - Input capture and Output compare channel 3	15
2.2.6	IOC2 - Input capture and Output compare channel 2	15
2.2.7	IOC1 - Input capture and Output compare channel 1	15
2.2.8	IOC0 - Input capture and Output compare channel 0	15

Section 3 Memory Map and Registers

3.1	Overview	17
3.2	Module Memory Map	17
3.3	Register Descriptions	19
3.3.1	TIOS — Timer Input Capture/Output Compare Select Register	19
3.3.2	CFORC — Timer Compare Force Register	20
3.3.3	OC7M — Output Compare 7 Mask Register	20
3.3.4	OC7D — Output Compare 7 Data Register	21
3.3.5	TCNT — Timer Count Register	21
3.3.6	TSCR1 — Timer System Control Register 1	22
3.3.7	TTOV — Timer Toggle On Overflow Register 1	23
3.3.8	TCTL1/TCTL2 — Timer Control Register 1/Timer Control Register 2	23
3.3.9	TCTL3/TCTL4 — Timer Control Register 3/Timer Control Register 4	24
3.3.10	TIE — Timer Interrupt Enable Register	25
3.3.11	TSCR2 — Timer System Control Register 2	25

3.3.12	TFLG1 — Main Timer Interrupt Flag 1	26
3.3.13	TFLG2 — Main Timer Interrupt Flag 2	27
3.3.14	Timer Input Capture/Output Compare Registers 0-7	28
3.3.15	PACTL — 16-Bit Pulse Accumulator A Control Register	29
3.3.16	PAFLG — Pulse Accumulator A Flag Register	31
3.3.17	PACN3, PACN2 — Pulse Accumulators Count Registers	32
3.3.18	PACN1, PACN0 — Pulse Accumulators Count Registers	33
3.3.19	MCCTL — 16-Bit Modulus Down-Counter Control Register	33
3.3.20	MCFLG — 16-Bit Modulus Down-Counter FLAG Register	35
3.3.21	ICPAR — Input Control Pulse Accumulators Register	36
3.3.22	DLYCT — Delay Counter Control Register	36
3.3.23	ICOVW — Input Control Overwrite Register	37
3.3.24	ICSYS — Input Control System Control Register	37
3.3.25	TIMTST — Timer Test Register	39
3.3.26	PBCTL — 16-Bit Pulse Accumulator B Control Register	39
3.3.27	PBFLG — Pulse Accumulator B Flag Register	40
3.3.28	PA3H–PA0H — 8-Bit Pulse Accumulators Holding Registers	41
3.3.29	MCCNT — Modulus Down-Counter Count Register	42
3.3.30	Timer Input Capture Holding Registers 0-3	43

Section 4 Functional Description

4.1	General	45
4.2	Enhanced Capture Timer Modes of Operation	50
4.2.1	IC Channels	50
4.2.1.1	Non-Buffered IC Channels	51
4.2.1.2	Buffered IC Channels	51
4.2.1.3	Delayed IC channels	51
4.2.2	Pulse Accumulators	52
4.2.2.1	Pulse Accumulator latch mode	53
4.2.2.2	Pulse Accumulator queue mode	53
4.2.3	Modulus Down-Counter	53
4.2.4	Channel Configurations	53

Section 5 Reset

5.1	General	55
-----	-------------------	----

Section 6 Interrupts

6.1	General	57
6.2	Description of Interrupt Operation	57
6.2.1	Channel [7:0] Interrupt	57
6.2.2	Modulus Counter Interrupt	57
6.2.3	Pulse Accumulator B Overflow Interrupt)	57
6.2.4	Pulse Accumulator A Input Interrupt	57
6.2.5	Pulse Accumulator A Overflow Interrupt	58
6.2.6	Timer Overflow Interrupt	58

Freescale Semiconductor, Inc.

List of Figures

Figure 1-1	Timer Block Diagram	14
Figure 3-1	Timer Input Capture/Output Compare Register (TIOS)	19
Figure 3-2	Timer Compare Force Register (CFORC)	20
Figure 3-3	Output Compare 7 Mask Register (OC7M)	20
Figure 3-4	Output Compare 7 Data Register (OC7D)	21
Figure 3-5	Timer Count Register (TCNT)	21
Figure 3-6	Timer System Control Register 1 (TSCR1)	22
Figure 3-7	Timer Toggle On Overflow Register 1 (TTOV)	23
Figure 3-8	Timer Control Register 1/Timer Control Register 2 (TCTL1/TCTL2)23	
Figure 3-9	Timer Control Register 3/Timer Control Register 4 (TCTL3/TCTL4)24	
Figure 3-10	Timer Interrupt Enable Register (TIE)	25
Figure 3-11	Timer System Control Register 2 (TSCR2)	25
Figure 3-12	Main Timer Interrupt Flag 1 (TFLG1)	26
Figure 3-13	Main Timer Interrupt Flag 2 (TFLG2)	27
Figure 3-14	Timer Input Capture/Output Compare Registers 0-7	29
Figure 3-15	16-Bit Pulse Accumulator Control Register (PACTL)	29
Figure 3-16	Pulse Accumulator A Flag Register (PAFLG)	31
Figure 3-17	Pulse Accumulators Count Register 3 (PACN3)	32
Figure 3-18	Pulse Accumulators Count Register 2 (PACN2)	32
Figure 3-19	Pulse Accumulators Count Register 1 (PACN1)	33
Figure 3-20	Pulse Accumulators Count Register 0 (PACN0)	33
Figure 3-21	16-Bit Modulus Down-Counter Control Register (MCCTL)	33
Figure 3-22	16-Bit Modulus Down-Counter FLAG Register (MCFLG)	35
Figure 3-23	Input Control Pulse Accumulators Register (ICPAR)	36
Figure 3-24	Delay Counter Control Register (DLYCT)	36
Figure 3-25	Input Control Overwrite Register (ICOVW)	37
Figure 3-26	Input Control System Register (ICSYS)	37
Figure 3-27	Timer Test Register (TIMTST)	39
Figure 3-28	16-Bit Pulse Accumulator B Control Register (PBCTL)	39
Figure 3-29	Pulse Accumulator B Flag Register (PBFLG)	40
Figure 3-30	8-Bit Pulse Accumulators Holding Register 3 (PA3H)	41
Figure 3-31	8-Bit Pulse Accumulators Holding Register 2 (PA2H)	41
Figure 3-32	8-Bit Pulse Accumulators Holding Register 1 (PA1H)	41

Figure 3-33	8-Bit Pulse Accumulators Holding Register 0 (PA0H)	41
Figure 3-34	Modulus Down-Counter Count Register (MCCNT)	42
Figure 3-35	Timer Input Capture Holding Register 0 (TC0H)	43
Figure 3-36	Timer Input Capture Holding Register 1 (TC1H)	43
Figure 3-37	Timer Input Capture Holding Register 2 (TC2H)	43
Figure 3-38	Timer Input Capture Holding Register 3 (TC3H)	43
Figure 4-1	Detailed Timer Block Diagram in Latch mode	46
Figure 4-2	Detailed Timer Block Diagram in Queue mode	47
Figure 4-3	8-Bit Pulse Accumulators Block Diagram	48
Figure 4-4	16-Bit Pulse Accumulators Block Diagram	49
Figure 4-5	Block Diagram for Port7 with Output compare/Pulse Accumulator A50	
Figure 4-6	Channel Input validity with delay counter feature	52

List of Tables

Table 3-1	Module Memory Map	17
Table 3-2	Compare Result Output Action	24
Table 3-3	Edge Detector Circuit Configuration	24
Table 3-4	Prescaler Selection	26
Table 3-5	Pin Action	30
Table 3-6	Clock Selection	30
Table 3-7	Modulus Counter Prescaler Select	34
Table 3-8	Delay Counter Select.	37
Table 6-1	ECT Interrupts	57

Freescale Semiconductor, Inc.

Freescale Semiconductor, Inc.



Section 1 Introduction

1.1 Overview

The HCS12 Enhanced Capture Timer module has the features of the HCS12 Standard Timer module enhanced by additional features in order to enlarge the field of applications, in particular for automotive ABS applications.

This design specification describes the standard timer as well as the additional features.

The basic timer consists of a 16-bit, software-programmable counter driven by a prescaler. This timer can be used for many purposes, including input waveform measurements while simultaneously generating an output waveform. Pulse widths can vary from microseconds to many seconds.

A full access for the counter registers or the input capture/output compare registers should take place in one clock cycle. Accessing high byte and low byte separately for all of these registers may not yield the same result as accessing them in one word.

1.2 Features

- 16-Bit Buffer Register for four Input Capture (IC) channels.
- Four 8-Bit Pulse Accumulators with 8-bit buffer registers associated with the four buffered IC channels. Configurable also as two 16-Bit Pulse Accumulators.
- 16-Bit Modulus Down-Counter with 4-bit Prescaler.
- Four user selectable Delay Counters for input noise immunity increase.

1.3 Modes of Operation

STOP:	Timer and modulus counter are off since clocks are stopped.
FREEZE:	Timer and modulus counter keep on running, unless TSFRZ in TSCR(\$06) is set to one.
WAIT:	Counters keep on running, unless TSWAI in TSCR (\$06) is set to one.
NORMAL:	Timer and modulus counter keep on running, unless TEN in TSCR(\$06) respectively MCEN in MCCTL (\$26) are cleared.

1.4 Block Diagram

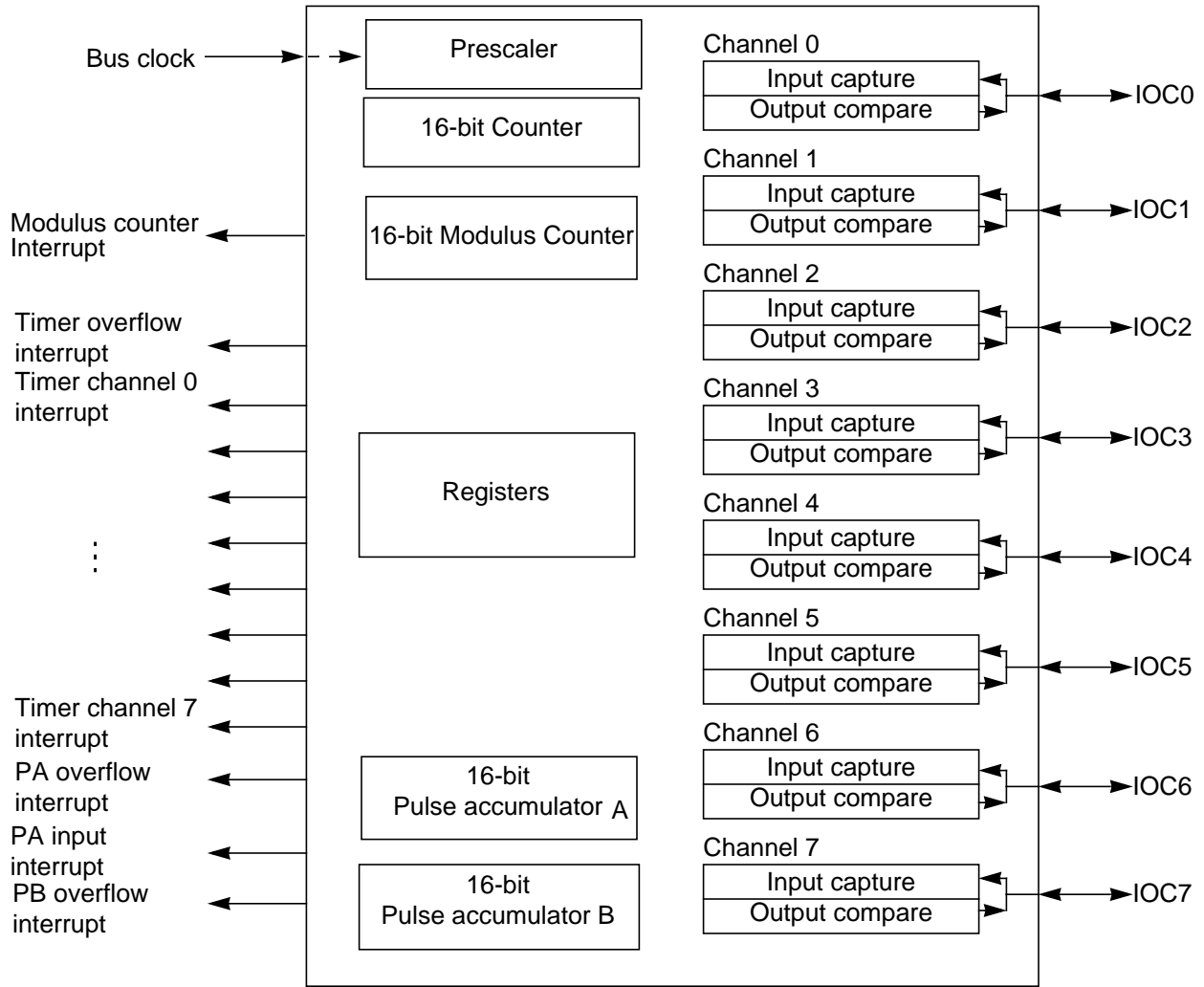

Figure 1-1 Timer Block Diagram

Section 2 Signal Description

2.1 Overview

The ECT_16B8C module has a total 8 external pins.

2.2 Detailed Signal Descriptions

2.2.1 IOC7 - Input capture and Output compare channel 7

This pin serves as input capture or output compare for channel 7.

2.2.2 IOC6 - Input capture and Output compare channel 6

This pin serves as input capture or output compare for channel 6.

2.2.3 IOC5 - Input capture and Output compare channel 5

This pin serves as input capture or output compare for channel 5.

2.2.4 IOC4 - Input capture and Output compare channel 4

This pin serves as input capture or output compare for channel 4.

2.2.5 IOC3 - Input capture and Output compare channel 3

This pin serves as input capture or output compare for channel 3.

2.2.6 IOC2 - Input capture and Output compare channel 2

This pin serves as input capture or output compare for channel 2.

2.2.7 IOC1 - Input capture and Output compare channel 1

This pin serves as input capture or output compare for channel 1.

2.2.8 IOC0 - Input capture and Output compare channel 0

This pin serves as input capture or output compare for channel 0.

NOTE: For the description of interrupts see Section 6 Interrupts.

Freescale Semiconductor, Inc.

Section 3 Memory Map and Registers

3.1 Overview

This section provides a detailed description of all memory and registers.

3.2 Module Memory Map

The memory map for the ECT module is given below in **Table 3-1**. The Address listed for each register is the address offset. The total address for each register is the sum of the base address for the ECT module and the address offset for each register.

Table 3-1 Module Memory Map

Offset	Use	Access
\$_00	Timer Input Capture/Output Compare Select (TIOS)	Read/Write
\$_01	Timer Compare Force Register (CFORC)	Read/Write ¹
\$_02	Output Compare 7 Mask Register (OC7M)	Read/Write
\$_03	Output Compare 7 Data Register (OC7D)	Read/Write
\$_04	Timer Count Register High (TCNT)	Read/Write ²
\$_05	Timer Count Register Low (TCNT)	Read/Write ²
\$_06	Timer System Control Register1 (TSCR1)	Read/Write
\$_07	Timer Toggle Overflow Register (TTOV)	Read/Write
\$_08	Timer Control Register1 (TCTL1)	Read/Write
\$_09	Timer Control Register2 (TCTL2)	Read/Write
\$_0A	Timer Control Register3 (TCTL3)	Read/Write
\$_0B	Timer Control Register4 (TCTL4)	Read/Write
\$_0C	Timer Interrupt Enable Register (TIE)	Read/Write
\$_0D	Timer System Control Register2 (TSCR2)	Read/Write
\$_0E	Main Timer Interrupt Flag1 (TFLG1)	Read/Write
\$_0F	Main Timer Interrupt Flag2 (TFLG2)	Read/Write
\$_10	Timer Input Capture/Output Compare Register0 High (TC0)	Read/Write ³
\$_11	Timer Input Capture/Output Compare Register0 Low (TC0)	Read/Write ³
\$_12	Timer Input Capture/Output Compare Register1 High (TC1)	Read/Write ³
\$_13	Timer Input Capture/Output Compare Register1 Low (TC1)	Read/Write ³
\$_14	Timer Input Capture/Output Compare Register2 High (TC2)	Read/Write ³
\$_15	Timer Input Capture/Output Compare Register2 Low (TC2)	Read/Write ³
\$_16	Timer Input Capture/Output Compare Register3 High (TC3)	Read/Write ³

Table 3-1 Module Memory Map

\$_17	Timer Input Capture/Output Compare Register3 Low (TC3)	Read/Write ³
\$_18	Timer Input Capture/Output Compare Register4 High (TC4)	Read/Write ³
\$_19	Timer Input Capture/Output Compare Register4 Low (TC4)	Read/Write ³
\$_1A	Timer Input Capture/Output Compare Register5 High (TC5)	Read/Write ³
\$_1B	Timer Input Capture/Output Compare Register5 Low (TC5)	Read/Write ³
\$_1C	Timer Input Capture/Output Compare Register6 High (TC6)	Read/Write ³
\$_1D	Timer Input Capture/Output Compare Register6 Low (TC6)	Read/Write ³
\$_1E	Timer Input Capture/Output Compare Register7 High (TC7)	Read/Write ³
\$_1F	Timer Input Capture/Output Compare Register7 Low (TC7)	Read/Write ³
\$_20	16-Bit Pulse Accumulator A Control Register (PACTL)	Read/Write
\$_21	Pulse Accumulator A Flag Register (PAFLG)	Read/Write
\$_22	Pulse Accumulator Count Register3 (PACN3)	Read/Write
\$_23	Pulse Accumulator Count Register2 (PACN2)	Read/Write
\$_24	Pulse Accumulator Count Register1 (PACN1)	Read/Write
\$_25	Pulse Accumulator Count Register0 (PACN0)	Read/Write
\$_26	16-Bit Modulus Down Counter Register (MCCTL)	Read/Write
\$_27	16-Bit Modulus Down Counter Flag Register (MCFLG)	Read/Write
\$_28	Input Control Pulse Accumulator Register (ICPAR)	Read/Write
\$_29	Delay Counter Control Register (DLYCT)	Read/Write
\$_2A	Input Control Overwrite Register (ICOVW)	Read/Write
\$_2B	Input Control System Control Register (ICSYS)	Read/Write ⁴
\$_2C	Reserved	--
\$_2D	Timer Test Register (TIMTST)	Read/Write ²
\$_2E	Reserved	--
\$_2F	Reserved	--
\$_30	16-Bit Pulse Accumulator B Control Register (PBCTL)	Read/Write
\$_31	16-Bit Pulse Accumulator B Flag Register (PBFLG)	Read/Write
\$_32	8-Bit Pulse Accumulator Holding Register3 (PA3H)	Read/Write ⁵
\$_33	8-Bit Pulse Accumulator Holding Register2 (PA2H)	Read/Write ⁵
\$_34	8-Bit Pulse Accumulator Holding Register1 (PA1H)	Read/Write ⁵
\$_35	8-Bit Pulse Accumulator Holding Register0 (PA0H)	Read/Write ⁵
\$_36	Modulus Down-Counter Count Register High (MCCNT)	Read/Write

Table 3-1 Module Memory Map

\$_37	Modulus Down-Counter Count Register Low (MCCNT)	Read/Write
\$_38	Timer Input Capture Holding Register0 High (TC0H)	Read/Write ⁵
\$_39	Timer Input Capture Holding Register0 Low (TC0L)	Read/Write ⁵
\$_3A	Timer Input Capture Holding Register1 High (TC1H)	Read/Write ⁵
\$_3B	Timer Input Capture Holding Register1 Low (TC1L)	Read/Write ⁵
\$_3C	Timer Input Capture Holding Register2 High (TC2H)	Read/Write ⁵
\$_3D	Timer Input Capture Holding Register2 Low (TC2L)	Read/Write ⁵
\$_3E	Timer Input Capture Holding Register3 High (TC3H)	Read/Write ⁵
\$_3F	Timer Input Capture Holding Register3 Low (TC3L)	Read/Write ⁵

1. Always read \$00.
2. Only writable in special modes (test_mode = 1).
3. Write to these registers have no meaning or effect during input capture.
4. May be written once (test_mode = 0) but writes are always permitted when test_mode = 0
5. Write has no effect.

3.3 Register Descriptions

This section consists of register descriptions in address order. Each description includes a standard register diagram with an associated figure number. Details of register bit and field function follow the register diagrams, in bit order.

3.3.1 TIOS — Timer Input Capture/Output Compare Select Register

Register offset: \$_00

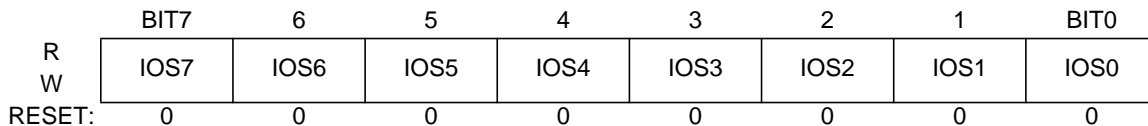

Figure 3-1 Timer Input Capture/Output Compare Register (TIOS)

Read or write anytime.

IOS[7:0] — Input Capture or Output Compare Channel Configuration

- 0 = The corresponding channel acts as an input capture
- 1 = The corresponding channel acts as an output compare.

3.3.2 CFORC — Timer Compare Force Register

Register offset: \$_01

	BIT7	6	5	4	3	2	1	BIT0
R	0	0	0	0	0	0	0	0
W	FOC7	FOC6	FOC5	FOC4	FOC3	FOC2	FOC1	FOC0
RESET:	0	0	0	0	0	0	0	0

Figure 3-2 Timer Compare Force Register (CFORC)

Read anytime but will always return \$00 (1 state is transient). Write anytime.

FOC[7:0] — Force Output Compare Action for Channel 7-0

A write to this register with the corresponding data bit(s) set causes the action which is programmed for output compare “n” to occur immediately. The action taken is the same as if a successful comparison had just taken place with the TCn register except the interrupt flag does not get set.

NOTE: *A successful channel 7 output compare overrides any channel 6:0 compares. If forced output compare on any channel occurs at the same time as the successful output compare then forced output compare action will take precedence and interrupt flag won't get set.*

3.3.3 OC7M — Output Compare 7 Mask Register

Register offset: \$_02

	BIT7	6	5	4	3	2	1	BIT0
R								
W	OC7M7	OC7M6	OC7M5	OC7M4	OC7M3	OC7M2	OC7M1	OC7M0
RESET:	0	0	0	0	0	0	0	0

Figure 3-3 Output Compare 7 Mask Register (OC7M)

Read or write anytime.

Setting the OC7Mn (n ranges from 0 to 6) bit of OC7M register configures the corresponding port to be an output port when the IOS7 bit and the corresponding IOSn (n ranges from 0 to 6) bit of TIOS register are set to be an output compare. Refer to the note on Section 4.2.4 for more insight.

NOTE: *A successful channel 7 output compare overrides any channel 6:0 compares. For each OC7M bit that is set, the output compare action reflects the corresponding OC7D bit.*

3.3.4 OC7D — Output Compare 7 Data Register

Register offset: $\$_03$

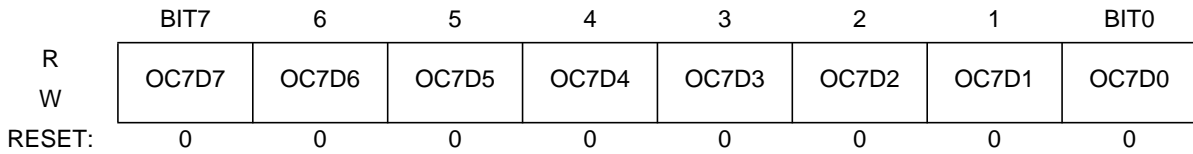

Figure 3-4 Output Compare 7 Data Register (OC7D)

Read or write anytime.

A channel 7 output compare can cause bits in the output compare 7 data register to transfer to the timer port data register depending on the output compare 7 mask register.

3.3.5 TCNT — Timer Count Register

Register offset: $\$_04$ - $\$_05$

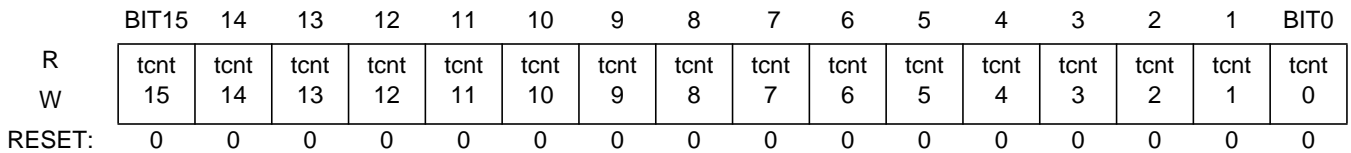

Figure 3-5 Timer Count Register (TCNT)

The 16-bit main timer is an up counter.

A full access for the counter register should take place in one clock cycle. A separate read (any mode)/ write (test mode) for high byte and low byte will give a different result than accessing them as a word.

Read anytime.

Write has no meaning or effect in the normal mode; only writable in special modes (test_mode = 1).

The period of the first count after a write to the TCNT registers may be a different size because the write is not synchronized with the prescaler clock.

3.3.6 TSCR1 — Timer System Control Register 1

Register offset: \$_06

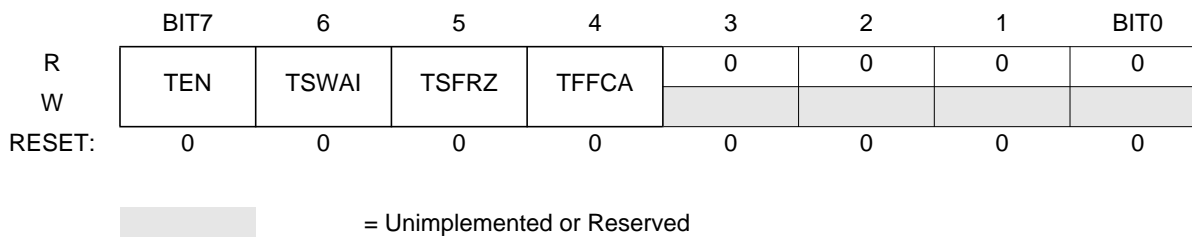

Figure 3-6 Timer System Control Register 1 (TSCR1)

Read or write anytime.

TEN — Timer Enable

- 0 = Disables the main timer, including the counter. Can be used for reducing power consumption.
- 1 = Allows the timer to function normally.

If for any reason the timer is not active, there is no ÷64 clock for the pulse accumulator since the ÷64 is generated by the timer prescaler.

TSWAI — Timer Module Stops While in Wait

- 0 = Allows the timer module to continue running during wait.
- 1 = Disables the timer module when the MCU is in the wait mode. Timer interrupts cannot be used to get the MCU out of wait.

TSWAI also affects pulse accumulators and modulus down counters.

TSFRZ — Timer and Modulus Counter Stop While in Freeze Mode

- 0 = Allows the timer and modulus counter to continue running while in freeze mode.
- 1 = Disables the timer and modulus counter whenever the MCU is in freeze mode. This is useful for emulation.

TSFRZ does not stop the pulse accumulator.

TFFCA — Timer Fast Flag Clear All

- 0 = Allows the timer flag clearing to function normally.
- 1 = For TFLG1(\$0E), a read from an input capture or a write to the output compare channel (\$10–\$1F) causes the corresponding channel flag, CnF, to be cleared. For TFLG2(\$0F), any access to the TCNT register (\$04, \$05) clears the TOF flag. Any access to the PACN3 and PACN2 registers (\$22, \$23) clears the PAOVF and PAIF flags in the PAFLG register (\$21). Any access to the PACN1 and PACN0 registers (\$24, \$25) clears the PBOVF flag in the PBFLG register (\$31). This has the advantage of eliminating software overhead in a separate clear sequence. Extra care is required to avoid accidental flag clearing due to unintended accesses.

3.3.7 TTOV — Timer Toggle On Overflow Register 1

Register offset: \$_07

	BIT7	6	5	4	3	2	1	BIT0
R	TOV7	TOV6	TOV5	TOV4	TOV3	TOV2	TOV1	TOV0
W								
RESET:	0	0	0	0	0	0	0	0

Figure 3-7 Timer Toggle On Overflow Register 1 (TTOV)

Read or write anytime.

TOVn — Toggle On Overflow Bits

TOVn toggles output compare pin on overflow. This feature only takes effect when in output compare mode. When set, it takes precedence over forced output compare but not channel 7 override events.

0 = Toggle output compare pin on overflow feature disabled

1 = Toggle output compare pin on overflow feature enabled

3.3.8 TCTL1/TCTL2 — Timer Control Register 1/Timer Control Register 2

Register offset: \$_08

	BIT7	6	5	4	3	2	1	BIT0
R	OM7	OL7	OM6	OL6	OM5	OL5	OM4	OL4
W								
RESET:	0	0	0	0	0	0	0	0

Register offset: \$_09

	BIT7	6	5	4	3	2	1	BIT0
R	OM3	OL3	OM2	OL2	OM1	OL1	OM0	OL0
W								
RESET:	0	0	0	0	0	0	0	0

Figure 3-8 Timer Control Register 1/Timer Control Register 2 (TCTL1/TCTL2)

Read or write anytime.

OMn — Output Mode

OLn — Output Level

These eight pairs of control bits are encoded to specify the output action to be taken as a result of a successful OCn(n varies from 0 to 7) compare. When either OMn or OLn is one, the port associated with OCn becomes an output tied to OCn when the corresponding IOSn bit of TIOS register is set and TEN bit of TSCR1 register is set. Refer to the note on Section 4.2.4 for more insight.

NOTE: To enable output action by *OMn* and *OLn* bits on timer port, the corresponding bit in *OC7M* should be cleared.

Table 3-2 Compare Result Output Action

OMn	OLn	Action
0	0	Timer disconnected from output pin logic
0	1	Toggle OCn output line
1	0	Clear OCn output line to zero
1	1	Set OCn output line to one

To operate the 16-bit pulse accumulators A and B (PACA and PACB) independently of input capture or output compare 7 and 0 respectively the user must set the corresponding bits *IOSn* = 1, *OMn* = 0 and *OLn* = 0. *OC7M7* or *OC7M0* in the *OC7M* register must also be cleared.

3.3.9 TCTL3/TCTL4 — Timer Control Register 3/Timer Control Register 4

Register offset: $\$_0A$

	BIT7	6	5	4	3	2	1	BIT0
R	EDG7B	EDG7A	EDG6B	EDG6A	EDG5B	EDG5A	EDG4B	EDG4A
W								
RESET:	0	0	0	0	0	0	0	0

Register offset: $\$_0B$

	BIT7	6	5	4	3	2	1	BIT0
R	EDG3B	EDG3A	EDG2B	EDG2A	EDG1B	EDG1A	EDG0B	EDG0A
W								
RESET:	0	0	0	0	0	0	0	0

Figure 3-9 Timer Control Register 3/Timer Control Register 4 (TCTL3/TCTL4)

Read or write anytime.

EDGnB, EDGnA — Input Capture Edge Control

These eight pairs of control bits configure the input capture edge detector circuits.

The four pairs of control bits of TCTL4 also configure the 8 bit pulse accumulators PAC0 - 3.

For 16 - bit pulse accumulator PACB, EDGE0B & EDGE0A, control bits of TCTL4 will decide the active edge.

Table 3-3 Edge Detector Circuit Configuration

EDGnB	EDGnA	Configuration
0	0	Capture disabled
0	1	Capture on rising edges only
1	0	Capture on falling edges only
1	1	Capture on any edge (rising or falling)

3.3.10 TIE — Timer Interrupt Enable Register

Register offset: $\$_{0C}$

	BIT7	6	5	4	3	2	1	BIT0
R	C7I	C6I	C5I	C4I	C3I	C2I	C1I	C0I
W	C7I	C6I	C5I	C4I	C3I	C2I	C1I	C0I
RESET:	0	0	0	0	0	0	0	0

Figure 3-10 Timer Interrupt Enable Register (TIE)

Read or write anytime.

The bits in TIE correspond bit-for-bit with the bits in the TFLG1 status register. If cleared, the corresponding flag is disabled from causing a hardware interrupt. If set, the corresponding flag is enabled to cause an interrupt.

C7I–C0I — Input Capture/Output Compare “n” Interrupt Enable

3.3.11 TSCR2 — Timer System Control Register 2

Register offset: $\$_{0D}$

	BIT7	6	5	4	3	2	1	BIT0
R	TOI	0	0	0	TCRE	PR2	PR1	PR0
W	TOI				TCRE	PR2	PR1	PR0
RESET:	0	0	0	0	0	0	0	0

= Unimplemented or Reserved

Figure 3-11 Timer System Control Register 2 (TSCR2)

Read or write anytime.

TOI — Timer Overflow Interrupt Enable

0 = Interrupt inhibited

1 = Hardware interrupt requested when TOF flag set

TCRE — Timer Counter Reset Enable

This bit allows the timer counter to be reset by a successful output compare 7 event. This mode of operation is similar to an up-counting modulus counter.

0 = Counter reset inhibited and counter free runs

1 = Counter reset by a successful output compare 7

If TC7 = $\$0000$ and TCRE = 1, TCNT will stay at $\$0000$ continuously. If TC7 = $\$FFFF$ and TCRE = 1, TOF will never be set when TCNT is reset from $\$FFFF$ to $\$0000$.

PR2, PR1, PR0 — Timer Prescaler Select

These three bits specify the number of +2 stages that are to be inserted between the bus clock and the main timer counter.

Table 3-4 Prescaler Selection

PR2	PR1	PR0	Prescale Factor
0	0	0	1
0	0	1	2
0	1	0	4
0	1	1	8
1	0	0	16
1	0	1	32
1	1	0	64
1	1	1	128

The newly selected prescale factor will not take effect until the next synchronized edge where all prescale counter stages equal zero.

3.3.12 TFLG1 — Main Timer Interrupt Flag 1

Register offset: **\$_0E**

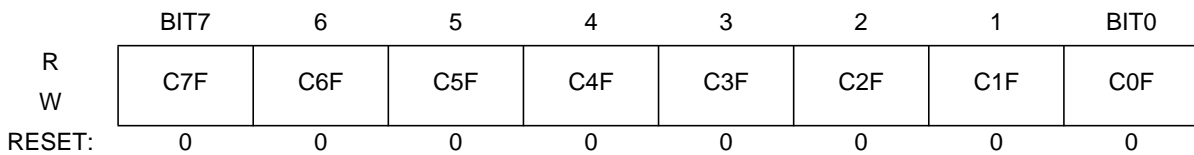

Figure 3-12 Main Timer Interrupt Flag 1 (TFLG1)

TFLG1 indicates when interrupt conditions have occurred. To clear a bit in the flag register, write a one to the bit.

Use of the TFMOD bit in the ICSYS register (\$2B) in conjunction with the use of the ICOVW register (\$2A) allows a timer interrupt to be generated after capturing two values in the capture and holding registers instead of generating an interrupt for every capture.

Read anytime. Write used in the clearing mechanism (set bits cause corresponding bits to be cleared). Writing a zero will not affect current status of the bit.

When TFFCA bit in TSCR register is set, a read from an input capture or a write into an output compare channel (\$10–\$1F) will cause the corresponding channel flag CnF to be cleared.

C7F–C0F — Input Capture/Output Compare Channel “n” Flag.

C0F can also be set by 16 - bit Pulse Accumulator B (PACB). C3F - C0F can also be set by 8 - bit pulse accumulators PAC3 - PAC0.

3.3.13 TFLG2 — Main Timer Interrupt Flag 2

Register offset: \$_0F

	BIT7	6	5	4	3	2	1	BIT0
R	TOF	0	0	0	0	0	0	0
W								
RESET:	0	0	0	0	0	0	0	0

 = Unimplemented or Reserved

Figure 3-13 Main Timer Interrupt Flag 2 (TFLG2)

TFLG2 indicates when interrupt conditions have occurred. To clear a bit in the flag register, write the bit to one.

Read anytime. Write used in clearing mechanism (set bits cause corresponding bits to be cleared).

Any access to TCNT will clear TFLG2 register if the TFFCA bit in TSCR register is set.

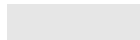
TOF — Timer Overflow Flag

Set when 16-bit free-running timer overflows from \$FFFF to \$0000. This bit is cleared automatically by a write to the TFLG2 register with bit 7 set. (See also TCRE control bit explanation.)

3.3.14 Timer Input Capture/Output Compare Registers 0-7

TC0 — Timer Input Capture/Output Compare Register 0 **Register offset: \$ _10-\$ _11**

	BIT15	14	13	12	11	10	9	8	7	6	5	4	3	2	1	BIT0
R	tc0	tc0	tc0	tc0	tc0	tc0	tc0	tc0	tc0	tc0	tc0	tc0	tc0	tc0	tc0	tc0
W	15	14	13	12	11	10	9	8	7	6	5	4	3	2	1	0
RESET	0	0	0	0	0	0	0	0	0	0	0	0	0	0	0	0

TC1 — Timer Input Capture/Output Compare Register 1 **Register offset: \$ _12-\$ _13**

	BIT15	14	13	12	11	10	9	8	7	6	5	4	3	2	1	BIT0
R	tc1	tc1	tc1	tc1	tc1	tc1	tc1	tc1	tc1	tc1	tc1	tc1	tc1	tc1	tc1	tc1
W	15	14	13	12	11	10	9	8	7	6	5	4	3	2	1	0
RESET	0	0	0	0	0	0	0	0	0	0	0	0	0	0	0	0

TC2 — Timer Input Capture/Output Compare Register 2 **Register offset: \$ _14-\$ _15**

	BIT15	14	13	12	11	10	9	8	7	6	5	4	3	2	1	BIT0
R	tc2	tc2	tc2	tc2	tc2	tc2	tc2	tc2	tc2	tc2	tc2	tc2	tc2	tc2	tc2	tc2
W	15	14	13	12	11	10	9	8	7	6	5	4	3	2	1	0
RESET	0	0	0	0	0	0	0	0	0	0	0	0	0	0	0	0

TC3 — Timer Input Capture/Output Compare Register 3 **Register offset: \$ _16-\$ _17**

	BIT15	14	13	12	11	10	9	8	7	6	5	4	3	2	1	BIT0
R	tc3	tc3	tc3	tc3	tc3	tc3	tc3	tc3	tc3	tc3	tc3	tc3	tc3	tc3	tc3	tc3
W	15	14	13	12	11	10	9	8	7	6	5	4	3	2	1	0
RESET	0	0	0	0	0	0	0	0	0	0	0	0	0	0	0	0

TC4 — Timer Input Capture/Output Compare Register 4 **Register offset: \$ _18-\$ _19**

	BIT15	14	13	12	11	10	9	8	7	6	5	4	3	2	1	BIT0
R	tc4	tc4	tc4	tc4	tc4	tc4	tc4	tc4	tc4	tc4	tc4	tc4	tc4	tc4	tc4	tc4
W	15	14	13	12	11	10	9	8	7	6	5	4	3	2	1	0
RESET	0	0	0	0	0	0	0	0	0	0	0	0	0	0	0	0

TC5 — Timer Input Capture/Output Compare Register 5 **Register offset: \$ _1A-\$ _1B**

	BIT15	14	13	12	11	10	9	8	7	6	5	4	3	2	1	BIT0
R	tc5	tc5	tc5	tc5	tc5	tc5	tc5	tc5	tc5	tc5	tc5	tc5	tc5	tc5	tc5	tc5
W	15	14	13	12	11	10	9	8	7	6	5	4	3	2	1	0
RESET	0	0	0	0	0	0	0	0	0	0	0	0	0	0	0	0

TC6 — Timer Input Capture/Output Compare Register 6 **Register offset: \$ _1C-\$ _1D**

	BIT15	14	13	12	11	10	9	8	7	6	5	4	3	2	1	BIT0
R	tc6	tc6	tc6	tc6	tc6	tc6	tc6	tc6	tc6	tc6	tc6	tc6	tc6	tc6	tc6	tc6
W	15	14	13	12	11	10	9	8	7	6	5	4	3	2	1	0
RESET	0	0	0	0	0	0	0	0	0	0	0	0	0	0	0	0

TC7 — Timer Input Capture/Output Compare Register 7 **Register offset: \$_1E–\$_1F**

	BIT15	14	13	12	11	10	9	8	7	6	5	4	3	2	1	BIT0
R	tc7	tc7	tc7	tc7	tc7	tc7	tc7	tc7	tc7	tc7	tc7	tc7	tc7	tc7	tc7	tc7
W	15	14	13	12	11	10	9	8	7	6	5	4	3	2	1	0
RESET	0	0	0	0	0	0	0	0	0	0	0	0	0	0	0	0

Figure 3-14 Timer Input Capture/Output Compare Registers 0-7

Depending on the TIOS bit for the corresponding channel, these registers are used to latch the value of the free-running counter when a defined transition is sensed by the corresponding input capture edge detector or to trigger an output action for output compare.

Read anytime. Write anytime for output compare function. Writes to these registers have no meaning or effect during input capture. All timer input capture/output compare registers are reset to \$0000.

3.3.15 PACTL — 16-Bit Pulse Accumulator A Control Register

Register offset: \$_20

	BIT7	6	5	4	3	2	1	BIT0
R	0	PAEN	PAMOD	PEDGE	CLK1	CLK0	PAOVI	PAI
W								
RESET:	0	0	0	0	0	0	0	0

 = Unimplemented or Reserved

Figure 3-15 16-Bit Pulse Accumulator Control Register (PACTL)

16-Bit Pulse Accumulator A (PACA) is formed by cascading the 8-bit pulse accumulators PAC3 and PAC2.

When PAEN is set, the PACA is enabled. The PACA shares the input pin with IC7.

Read: any time

Write: any time

PAEN — Pulse Accumulator A System Enable

0 = 16-Bit Pulse Accumulator A system disabled. 8-bit PAC3 and PAC2 can be enabled when their related enable bits in ICPAR (\$28) are set.

Pulse Accumulator Input Edge Flag (PAIF) function is disabled.

1 = 16-Bit Pulse Accumulator A system enabled. The two 8-bit pulse accumulators PAC3 and PAC2 are cascaded to form the PACA 16-bit pulse accumulator. When PACA is enabled, the PACN3 and PACN2 registers contents are respectively the high and low byte of the PACA.

PA3EN and PA2EN control bits in ICPAR (\$28) have no effect.

Pulse Accumulator Input Edge Flag (PAIF) function is enabled.

PAEN is independent from TEN. With timer disabled, the pulse accumulator can still function unless pulse accumulator is disabled.

PAMOD — Pulse Accumulator Mode

This bit is active only when the Pulse Accumulator A is enabled (PAEN = 1).

0 = event counter mode

1 = gated time accumulation mode

PEDGE — Pulse Accumulator Edge Control

This bit is active only when the Pulse Accumulator A is enabled (PAEN = 1).

For PAMOD bit = 0 (event counter mode).

0 = falling edges on PT7 pin cause the count to be incremented

1 = rising edges on PT7 pin cause the count to be incremented

For PAMOD bit = 1 (gated time accumulation mode).

0 = PT7 input pin high enables bus clock divided by 64 to Pulse Accumulator and the trailing falling edge on PT7 sets the PAIF flag.

1 = PT7 input pin low enables bus clock divided by 64 to Pulse Accumulator and the trailing rising edge on PT7 sets the PAIF flag

Table 3-5 Pin Action

PAMOD	PEDGE	Pin Action
0	0	Falling edge
0	1	Rising edge
1	0	Div. by 64 clock enabled with pin high level
1	1	Div. by 64 clock enabled with pin low level

If the timer is not active (TEN = 0 in TSCR), there is no divide-by-64 since the ÷64 clock is generated by the timer prescaler.

CLK1, CLK0 — Clock Select Bits**Table 3-6 Clock Selection**

CLK1	CLK0	Clock Source
0	0	Use timer prescaler clock as timer counter clock
0	1	Use PCLK as input to timer counter clock
1	0	Use PCLK/256 as timer counter clock frequency
1	1	Use PCLK/65536 as timer counter clock frequency

For the description of PCLK please refer **Figure 4-4**.

If the pulse accumulator is disabled (PAEN = 0), the prescaler clock from the timer is always used as an input clock to the timer counter. The change from one selected clock to the other happens immediately after these bits are written.

PAOVI — Pulse Accumulator A Overflow Interrupt enable

0 = interrupt inhibited

1 = interrupt requested if PAOVF is set

PAI — Pulse Accumulator Input Interrupt enable

0 = interrupt inhibited

1 = interrupt requested if PAIF is set

3.3.16 PAFLG — Pulse Accumulator A Flag Register

Register offset: \$_21

	BIT7	6	5	4	3	2	1	BIT0
R	0	0	0	0	0	0	PAOVF	PAIF
W								
RESET:	0	0	0	0	0	0	0	0

= Unimplemented or Reserved

Figure 3-16 Pulse Accumulator A Flag Register (PAFLG)

Read or write anytime. When the TFFCA bit in the TSCR register is set, any access to the PACNT register will clear all the flags in the PAFLG register.

PAOVF — Pulse Accumulator A Overflow Flag

Set when the 16-bit pulse accumulator A overflows from \$FFFF to \$0000, or when 8-bit pulse accumulator 3 (PAC3) overflows from \$FF to \$00.

When PACMX = 1, PAOVF bit can also be set if 8-bit pulse accumulator 3 (PAC3) reaches \$FF followed by an active edge on PT3.

This bit is cleared automatically by a write to the PAFLG register with bit 1 set.

PAIF — Pulse Accumulator Input edge Flag

Set when the selected edge is detected at the PT7 input pin. In event mode the event edge triggers PAIF and in gated time accumulation mode the trailing edge of the gate signal at the PT7 input pin triggers PAIF.

This bit is cleared by a write to the PAFLG register with bit 0 set.

Any access to the PACN3, PACN2 registers will clear all the flags in this register when TFFCA bit in register TSCR(\$06) is set.

3.3.17 PACN3, PACN2 — Pulse Accumulators Count Registers

Register offset: \$_22

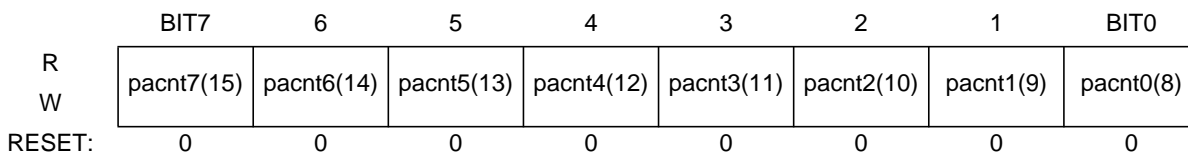

Figure 3-17 Pulse Accumulators Count Register 3 (PACN3)

Register offset: \$_23

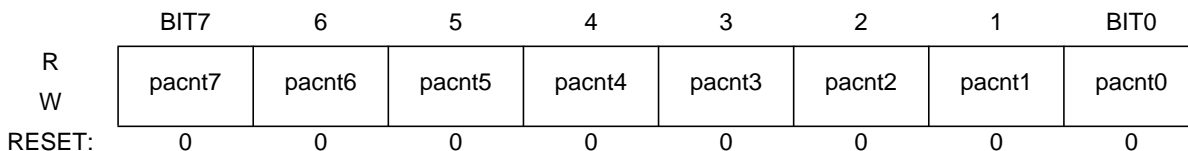

Figure 3-18 Pulse Accumulators Count Register 2 (PACN2)

Read or write any time.

The two 8-bit pulse accumulators PAC3 and PAC2 are cascaded to form the PACA 16-bit pulse accumulator. When PACA is enabled (PAEN=1 in PACTL, \$20) the PACN3 and PACN2 registers contents are respectively the high and low byte of the PACA.

When PACN3 overflows from \$FF to \$00, the Interrupt flag PAOVF in PAFLG (\$21) is set.

Full count register access should take place in one clock cycle. A separate read/write for high byte and low byte will give a different result than accessing them as a word.

NOTE : *When clocking pulse and write to the registers occurs simultaneously, write takes priority and the register is not incremented.*

3.3.18 PACN1, PACN0 — Pulse Accumulators Count Registers

Register offset: \$_24

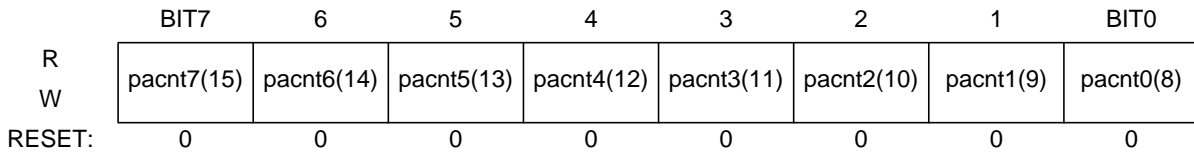

Figure 3-19 Pulse Accumulators Count Register 1 (PACN1)

Register offset: \$_25

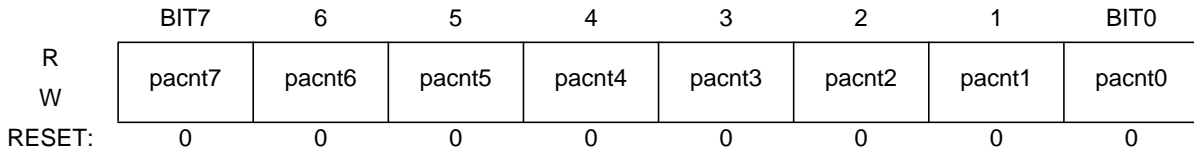

Figure 3-20 Pulse Accumulators Count Register 0 (PACN0)

Read or write any time.

The two 8-bit pulse accumulators PAC1 and PAC0 are cascaded to form the PACB 16-bit pulse accumulator. When PACB is enabled, (PBEN=1 in PBCTL, \$30) the PACN1 and PACN0 registers contents are respectively the high and low byte of the PACB.

When PACN1 overflows from \$FF to \$00, the Interrupt flag PBOVF in PBFLG (\$31) is set.

Full count register access should take place in one clock cycle. A separate read/write for high byte and low byte will give a different result than accessing them as a word

NOTE : When clocking pulse and write to the registers occurs simultaneously , write takes priority and the register is not incremented.

3.3.19 MCCTL — 16-Bit Modulus Down-Counter Control Register

Register offset: \$_26

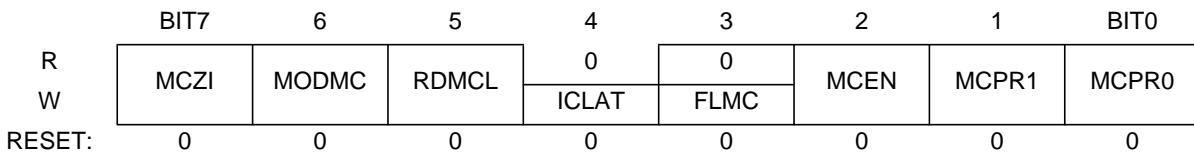

Figure 3-21 16-Bit Modulus Down-Counter Control Register (MCCTL)

Read or write any time.

MCZI — Modulus Counter Underflow Interrupt Enable
 0 = Modulus counter interrupt is disabled.

1 = Modulus counter interrupt is enabled.

MODMC — Modulus Mode Enable

0 = The counter counts once from the value written to it and will stop at \$0000.

1 = Modulus mode is enabled. When the counter reaches \$0000, the counter is loaded with the latest value written to the modulus count register.

NOTE: For proper operation, the MCEN bit should be cleared before modifying the MODMC bit in order to reset the modulus counter to \$FFFF.

RDMCL — Read Modulus Down-Counter Load

0 = Reads of the modulus count register will return the present value of the count register.

1 = Reads of the modulus count register will return the contents of the load register.

ICLAT — Input Capture Force Latch Action

When input capture latch mode is enabled (LATQ and BUFEN bit in ICSYS (\$2B) are set, a write one to this bit immediately forces the contents of the input capture registers TC0 to TC3 and their corresponding 8-bit pulse accumulators to be latched into the associated holding registers. The pulse accumulators will be automatically cleared when the latch action occurs.

Writing zero to this bit has no effect. Read of this bit will return always zero.

FLMC — Force Load Register into the Modulus Counter Count Register

This bit is active only when the modulus down-counter is enabled (MCEN=1).

A write one into this bit loads the load register into the modulus counter count register. This also resets the modulus counter prescaler.

Write zero to this bit has no effect.

When MODMC=0, counter starts counting and stops at \$0000.

Read of this bit will return always zero.

MCEN — Modulus Down-Counter Enable

0 = Modulus counter disabled.

1 = Modulus counter is enabled.

When MCEN=0, the counter is preset to \$FFFF. This will prevent an early interrupt flag when the modulus down-counter is enabled.

MCPR1, MCPR0 — Modulus Counter Prescaler select

These two bits specify the division rate of the modulus counter prescaler.

The newly selected prescaler division rate will not be effective until a load of the load register into the modulus counter count register occurs.

Table 3-7 Modulus Counter Prescaler Select

MCPR1	MCPR0	Prescaler division rate
0	0	1

Table 3-7 Modulus Counter Prescaler Select

M CPR1	M CPR0	Prescaler division rate
0	1	4
1	0	8
1	1	16

3.3.20 MCFLG — 16-Bit Modulus Down-Counter FLAG Register

Register offset: \$_27

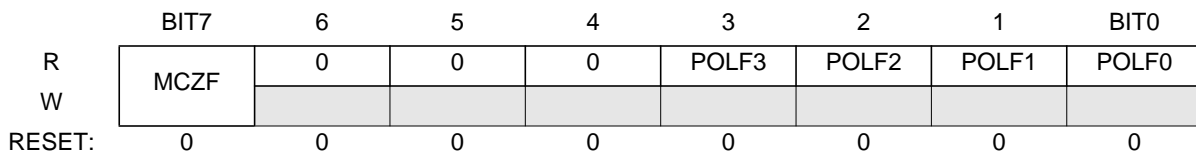

 = Unimplemented or Reserved

Figure 3-22 16-Bit Modulus Down-Counter FLAG Register (MCFLG)

Read: any time

Write: Only for clearing bit 7

MCZF — Modulus Counter Underflow Flag

The flag is set when the modulus down-counter reaches \$0000.

A write one to this bit clears the flag. Write zero has no effect.

Any access to the MCCNT register will clear the MCZF flag in this register when TFFCA bit in register TSCR(\$06) is set.

POLF3 – POLF0 — First Input Capture Polarity Status

This are read only bits. Write to these bits has no effect.

Each status bit gives the polarity of the first edge which has caused an input capture to occur after capture latch has been read.

Each POLFn corresponds to a timer PORTn input.

0 = The first input capture has been caused by a falling edge.

1 = The first input capture has been caused by a rising edge.

3.3.21 ICPAR — Input Control Pulse Accumulators Register

Register offset: \$_28

	BIT7	6	5	4	3	2	1	BIT0
R	0	0	0	0	PA3EN	PA2EN	PA1EN	PA0EN
W								
RESET:	0	0	0	0	0	0	0	0

 = Unimplemented or Reserved

Figure 3-23 Input Control Pulse Accumulators Register (ICPAR)

The 8-bit pulse accumulators PAC3 and PAC2 can be enabled only if PAEN in PATCL (\$20) is cleared. If PAEN is set, PA3EN and PA2EN have no effect.

The 8-bit pulse accumulators PAC1 and PAC0 can be enabled only if PBEN in PBTCL (\$30) is cleared. If PBEN is set, PA1EN and PA0EN have no effect.

Read or write any time.

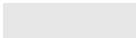
PAnEN — 8-Bit Pulse Accumulator Enable

0 = 8-Bit Pulse Accumulator is disabled.

1 = 8-Bit Pulse Accumulator is enabled.

3.3.22 DLYCT — Delay Counter Control Register

Register offset: \$_29

	BIT7	6	5	4	3	2	1	BIT0
R	0	0	0	0	0	0	DLY1	DLY0
W								
RESET:	0	0	0	0	0	0	0	0

 = Unimplemented or Reserved

Figure 3-24 Delay Counter Control Register (DLYCT)

Read or write any time.

If enabled, after detection of a valid edge on input capture pin, the delay counter counts the pre-selected number of bus clock cycles, then it will generate a pulse on its output. The pulse is generated only if the level of input signal, after the preset delay, is the opposite of the level before the transition. This will avoid reaction to narrow input pulses.

After counting, the counter will be cleared automatically.

Delay between two active edges of the input signal period should be longer than the selected counter delay.

DLYn — Delay Counter Select

Table 3-8 Delay Counter Select

DLY1	DLY0	Delay
0	0	Disabled (bypassed)
0	1	256 bus clock cycles
1	0	512 bus clock cycles
1	1	1024 bus clock cycles

3.3.23 ICOVW — Input Control Overwrite Register

Register offset: \$_2A

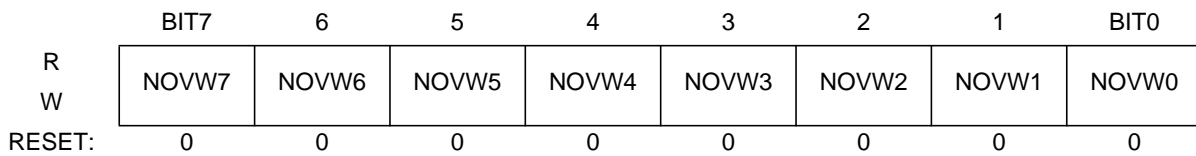

Figure 3-25 Input Control Overwrite Register (ICOVW)

Read or write any time.

An IC register is empty when it has been read or latched into the holding register.

A holding register is empty when it has been read.

NOVWn — No Input Capture Overwrite

- 0 = The contents of the related capture register or holding register can be overwritten when a new input capture or latch occurs.
- 1 = The related capture register or holding register cannot be written by an event unless they are empty (see **4.2.1 IC Channels**). This will prevent the captured value to be overwritten until it is read or latched in the holding register.

3.3.24 ICSYS — Input Control System Control Register

Register offset: \$_2B

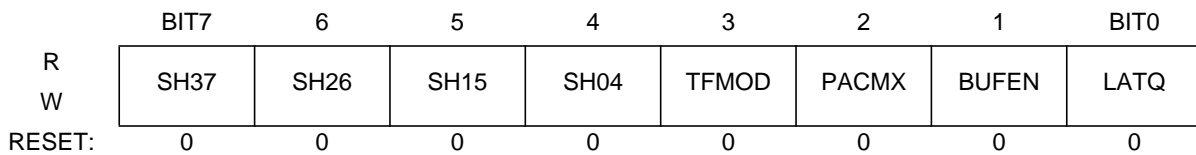

Figure 3-26 Input Control System Register (ICSYS)

Read: any time

Write: Can be written once (test_mode =0). Writes are always permitted when test_mode =1.

SHxy — Share Input action of Input Capture Channels x and y

0 = Normal operation

1 = The channel input 'x' causes the same action on the channel 'y'. The port pin 'x' and the corresponding edge detector is used to be active on the channel 'y'.

TFMOD — Timer Flag-setting Mode

Use of the TFMOD bit in the ICSYS register (\$2B) in conjunction with the use of the ICOVW register (\$2A) allows a timer interrupt to be generated after capturing two values in the capture and holding registers instead of generating an interrupt for every capture.

By setting TFMOD in queue mode, when NOVW bit is set and the corresponding capture and holding registers are emptied, an input capture event will first update the related input capture register with the main timer contents. At the next event the TCn data is transferred to the TCnH register, The TCn is updated and the CnF interrupt flag is set.

In all other input capture cases the interrupt flag is set by a valid external event on PTn.

0 = The timer flags C3F–C0F in TFLG1 (\$0E) are set when a valid input capture transition on the corresponding port pin occurs.

1 = If in queue mode (BUFEN=1 and LATQ=0), the timer flags C3F–C0F in TFLG1 (\$0E) are set only when a latch on the corresponding holding register occurs.

If the queue mode is not engaged, the timer flags C3F–C0F are set the same way as for TFMOD=0.

PACMX — 8-Bit Pulse Accumulators Maximum Count

0 = Normal operation. When the 8-bit pulse accumulator has reached the value \$FF, with the next active edge, it will be incremented to \$00.

1 = When the 8-bit pulse accumulator has reached the value \$FF, it will not be incremented further. The value \$FF indicates a count of 255 or more.

BUFEN — IC Buffer Enable

0 = Input Capture and pulse accumulator holding registers are disabled.

1 = Input Capture and pulse accumulator holding registers are enabled. The latching mode is defined by LATQ control bit.

Write one into ICLAT bit in MCCTL (\$26), when LATQ is set will produce latching of input capture and pulse accumulators registers into their holding registers.

LATQ — Input Control Latch or Queue Mode Enable

The BUFEN control bit should be set in order to enable the IC and pulse accumulators holding registers. Otherwise LATQ latching modes are disabled.

Write one into ICLAT bit in MCCTL (\$26), when LATQ and BUFEN are set will produce latching of input capture and pulse accumulators registers into their holding registers.

0 = Queue Mode of Input Capture is enabled.

The main timer value is memorized in the IC register by a valid input pin transition.

With a new occurrence of a capture, the value of the IC register will be transferred to its holding register and the IC register memorizes the new timer value.

1 = Latch Mode is enabled. Latching function occurs when modulus down-counter reaches zero or a zero is written into the count register MCCNT (see **4.2.1.2 Buffered IC Channels**).

With a latching event the contents of IC registers and 8-bit pulse accumulators are transferred to their holding registers. 8-bit pulse accumulators are cleared.

3.3.25 TIMTST — Timer Test Register

Register offset: \$_2D

	BIT7	6	5	4	3	2	1	BIT0
R	0	0	0	0	0	0	TCBYP	0
W								
RESET:	0	0	0	0	0	0	0	0

= Unimplemented or Reserved

Figure 3-27 Timer Test Register (TIMTST)

Read: any time

Write: only in special mode (test_mode = 1).

TCBYP — Main Timer Divider Chain Bypass

0 = Normal operation

1 = For testing only. The 16-bit free-running timer counter is divided into two 8-bit halves and the prescaler is bypassed. The clock drives both halves directly.

When the high byte of timer counter TCNT (\$04) overflows from \$FF to \$00, the TOF flag in TFLG2 (\$0F) will be set.

3.3.26 PBCTL — 16-Bit Pulse Accumulator B Control Register

Register offset: \$_30

	BIT7	6	5	4	3	2	1	BIT0
R	0	PBEN	0	0	0	0	PBOVI	0
W								
RESET:	0	0	0	0	0	0	0	0

= Unimplemented or Reserved

Figure 3-28 16-Bit Pulse Accumulator B Control Register (PBCTL)

Read or write any time.

16-Bit Pulse Accumulator B (PACB) is formed by cascading the 8-bit pulse accumulators PAC1 and PAC0.

When PBEN is set, the PACB is enabled. The PACB shares the input pin with IC0.

PBEN — Pulse Accumulator B System Enable

0 = 16-bit Pulse Accumulator system disabled. 8-bit PAC1 and PAC0 can be enabled when their related enable bits in ICPAR (\$28) are set.

1 = Pulse Accumulator B system enabled. The two 8-bit pulse accumulators PAC1 and PAC0 are cascaded to form the PACB 16-bit pulse accumulator. When PACB is enabled, the PACN1 and PACN0 registers contents are respectively the high and low byte of the PACB. PA1EN and PA0EN control bits in ICPAR (\$28) have no effect.

PBEN is independent from TEN. With timer disabled, the pulse accumulator can still function unless pulse accumulator is disabled.

PBOVI — Pulse Accumulator B Overflow Interrupt enable

0 = interrupt inhibited

1 = interrupt requested if PBOVF is set

3.3.27 PBFLG — Pulse Accumulator B Flag Register

Register offset: \$_31

	BIT7	6	5	4	3	2	1	BIT0
R	0	0	0	0	0	0	PBOVF	0
W								
RESET:	0	0	0	0	0	0	0	0

 = Unimplemented or Reserved

Figure 3-29 Pulse Accumulator B Flag Register (PBFLG)

Read or write any time.

PBOVF — Pulse Accumulator B Overflow Flag

This bit is set when the 16-bit pulse accumulator B overflows from \$FFFF to \$0000, or when 8-bit pulse accumulator 1 (PAC1) overflows from \$FF to \$00.

This bit is cleared by a write to the PBFLG register with bit 1 set.

Any access to the PACN1 and PACN0 registers will clear the PBOVF flag in this register when TFFCA bit in register TSCR(\$06) is set.

When PACMX = 1, PBOVF bit can also be set if 8-bit pulse accumulator 1 (PAC1) reaches \$FF and followed an active edge comes on PT1.

3.3.28 PA3H–PA0H — 8-Bit Pulse Accumulators Holding Registers

Register offset: \$_32

	BIT7	6	5	4	3	2	1	BIT0
R	PA3H7	PA3H6	PA3H5	PA3H4	PA3H3	PA3H2	PA3H1	PA3H0
W								
RESET:	0	0	0	0	0	0	0	0

 = Unimplemented or Reserved

Figure 3-30 8-Bit Pulse Accumulators Holding Register 3 (PA3H)

Register offset: \$_33

	BIT7	6	5	4	3	2	1	BIT0
R	PA2H7	PA2H6	PA2H5	PA2H4	PA2H3	PA2H2	PA2H1	PA2H0
W								
RESET:	0	0	0	0	0	0	0	0

 = Unimplemented or Reserved

Figure 3-31 8-Bit Pulse Accumulators Holding Register 2 (PA2H)

Register offset: \$_34

	BIT7	6	5	4	3	2	1	BIT0
R	PA1H7	PA1H6	PA1H5	PA1H4	PA1H3	PA1H2	PA1H1	PA1H0
W								
RESET:	0	0	0	0	0	0	0	0

 = Unimplemented or Reserved

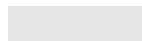
Figure 3-32 8-Bit Pulse Accumulators Holding Register 1 (PA1H)

Register offset: \$_35

	BIT7	6	5	4	3	2	1	BIT0
R	PA0H7	PA0H6	PA0H5	PA0H4	PA0H3	PA0H2	PA0H1	PA0H0
W								
RESET:	0	0	0	0	0	0	0	0

 = Unimplemented or Reserved

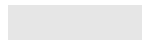
Figure 3-33 8-Bit Pulse Accumulators Holding Register 0 (PA0H)

Read: any time

Write: has no effect.

These registers are used to latch the value of the corresponding pulse accumulator when the related bits in register ICPAR (\$28) are enabled (see **4.2.2 Pulse Accumulators**).

3.3.29 MCCNT — Modulus Down-Counter Count Register

Register address: \$36-\$37

	BIT15	14	13	12	11	10	9	8	7	6	5	4	3	2	1	BIT0
R	mccnt	mccnt	mccnt	mccnt	mccnt	mccnt	mccnt	mccnt	mccnt	mccnt	mccnt	mccnt	mccnt	mccnt	mccnt	mccnt
W	15	14	13	12	11	10	9	8	7	6	5	4	3	2	1	0
RESET	1	1	1	1	1	1	1	1	1	1	1	1	1	1	1	1

Figure 3-34 Modulus Down-Counter Count Register (MCCNT)

Read or write any time.

A full access for the counter register should take place in one clock cycle. A separate read/write for high byte and low byte will give different result than accessing them as a word.

If the RDMCL bit in MCCTL register is cleared, reads of the MCCNT register will return the present value of the count register. If the RDMCL bit is set, reads of the MCCNT will return the contents of the load register.

If a \$0000 is written into MCCNT and modulus counter while LATQ and BUFEN in ICSYS (\$2B) register are set, the input capture and pulse accumulator registers will be latched.

With a \$0000 write to the MCCNT, the modulus counter will stay at zero and does not set the MCZF flag in MCFLG register.

If modulus mode is enabled (MODMC=1), a write to this address will update the load register with the value written to it. The count register will not be updated with the new value until the next counter underflow.

The FLMC bit in MCCTL (\$26) can be used to immediately update the count register with the new value if an immediate load is desired.

If modulus mode is not enabled (MODMC=0), a write to this address will clear the prescaler and will immediately update the counter register with the value written to it and down-counts once to \$0000.

3.3.30 Timer Input Capture Holding Registers 0-3

Register offset: \$_38-\$_39

	BIT15	14	13	12	11	10	9	8	7	6	5	4	3	2	1	BIT0
R	TC15	TC14	TC13	TC12	TC11	TC10	TC9	TC8	TC7	TC6	TC5	TC4	TC3	TC2	TC1	TC0
W																
RESET:	0	0	0	0	0	0	0	0	0	0	0	0	0	0	0	0

 = Unimplemented or Reserved

Figure 3-35 Timer Input Capture Holding Register 0 (TC0H)

Register offset: \$_3A-\$_3B

	BIT15	14	13	12	11	10	9	8	7	6	5	4	3	2	1	BIT0
R	TC15	TC14	TC13	TC12	TC11	TC10	TC9	TC8	TC7	TC6	TC5	TC4	TC3	TC2	TC1	TC0
W																
RESET:	0	0	0	0	0	0	0	0	0	0	0	0	0	0	0	0

 = Unimplemented or Reserved

Figure 3-36 Timer Input Capture Holding Register 1 (TC1H)

Register offset: \$_3C-\$_3D

	BIT15	14	13	12	11	10	9	8	7	6	5	4	3	2	1	BIT0
R	TC15	TC14	TC13	TC12	TC11	TC10	TC9	TC8	TC7	TC6	TC5	TC4	TC3	TC2	TC1	TC0
W																
RESET:	0	0	0	0	0	0	0	0	0	0	0	0	0	0	0	0

 = Unimplemented or Reserved

Figure 3-37 Timer Input Capture Holding Register 2 (TC2H)

Register offset: \$_3E-\$_3F

	BIT15	14	13	12	11	10	9	8	7	6	5	4	3	2	1	BIT0
R	TC15	TC14	TC13	TC12	TC11	TC10	TC9	TC8	TC7	TC6	TC5	TC4	TC3	TC2	TC1	TC0
W																
RESET:	0	0	0	0	0	0	0	0	0	0	0	0	0	0	0	0

 = Unimplemented or Reserved

Figure 3-38 Timer Input Capture Holding Register 3 (TC3H)

Read: any time

Write: has no effect.

These registers are used to latch the value of the input capture registers TC0 – TC3. The corresponding IOSn bits in TIOS (\$00) should be cleared (see **4.2.1 IC Channels**).

Section 4 Functional Description

4.1 General

This section provides a complete functional description of the ECT block, detailing the operation of the design from the end user perspective in a number of subsections.

Refer to the Timer Block Diagrams from **Figure 4-1** to **Figure 4-5** as necessary.

Figure 4-1 Detailed Timer Block Diagram in Latch mode

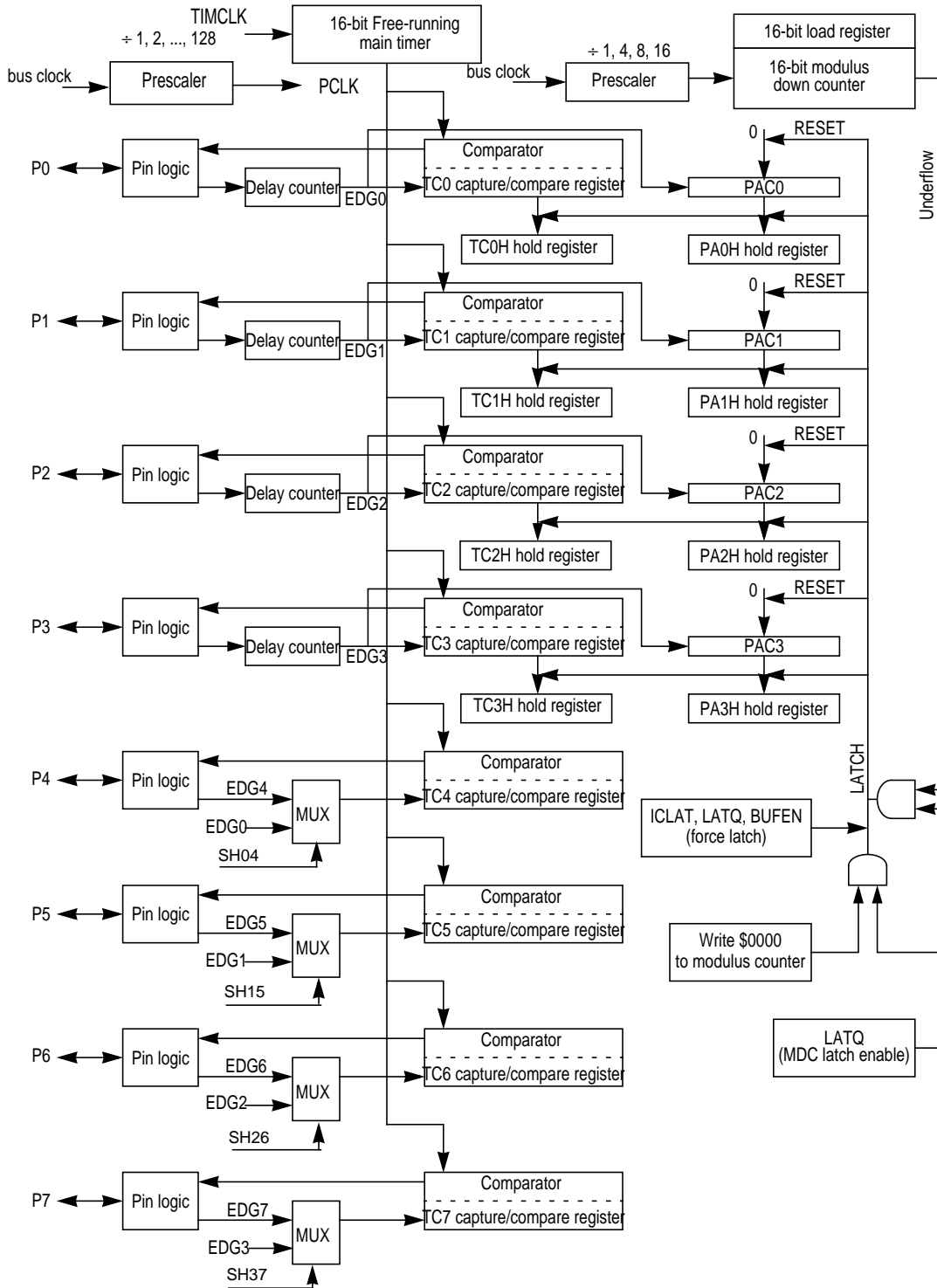
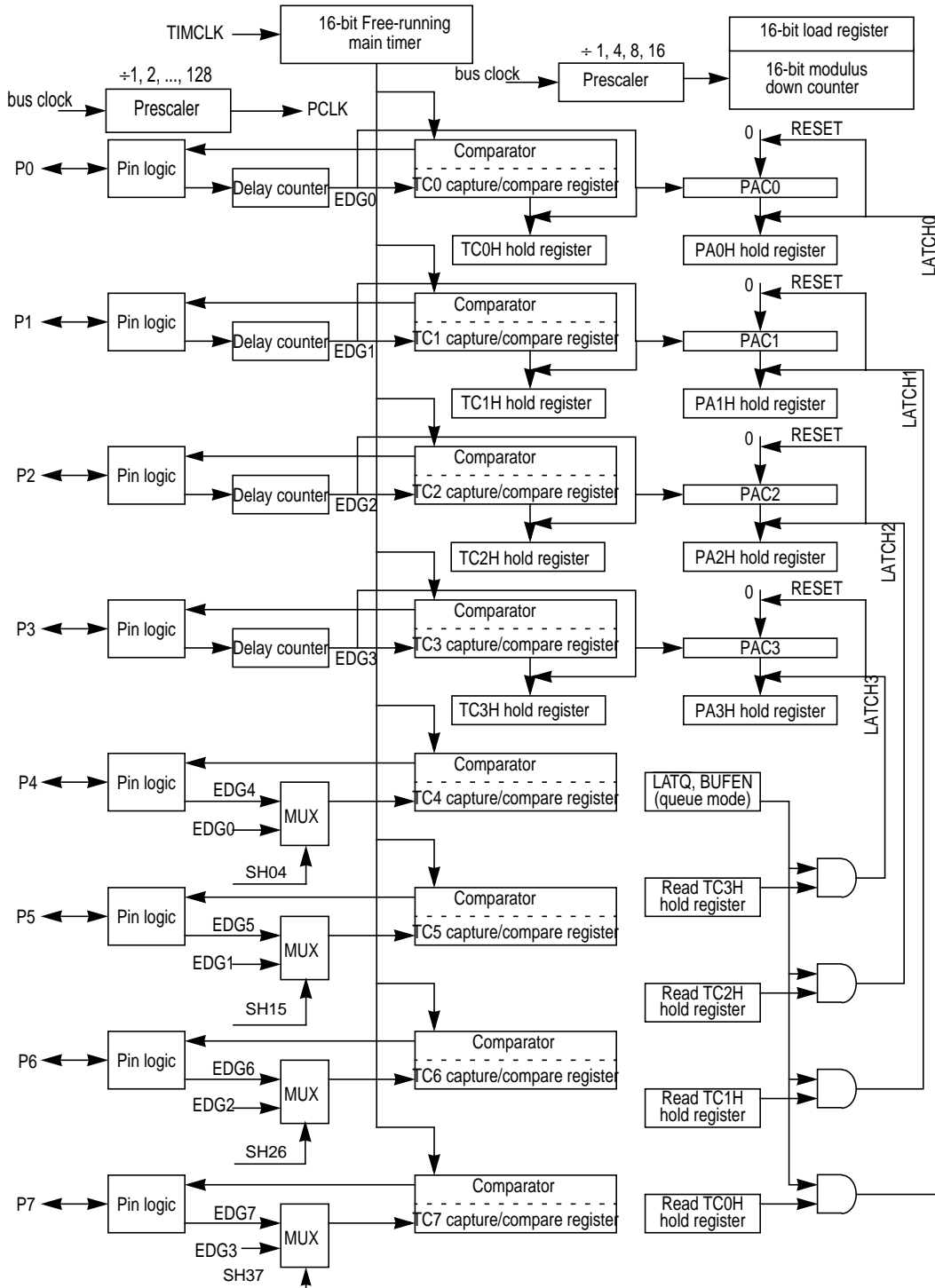

Figure 4-2 Detailed Timer Block Diagram in Queue mode



Freescale Semiconductor, Inc.

Figure 4-3 8-Bit Pulse Accumulators Block Diagram

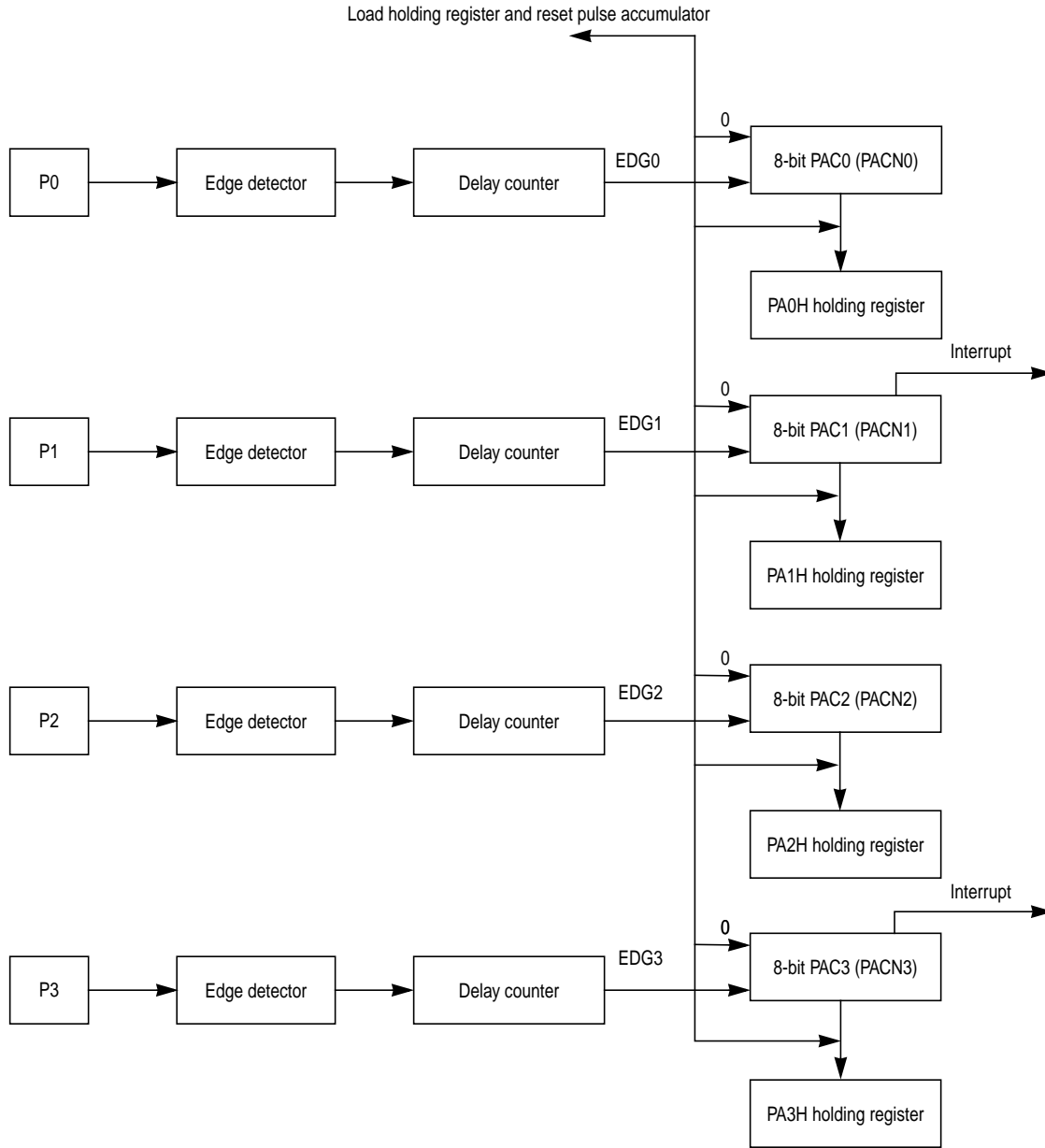

Figure 4-4 16-Bit Pulse Accumulators Block Diagram

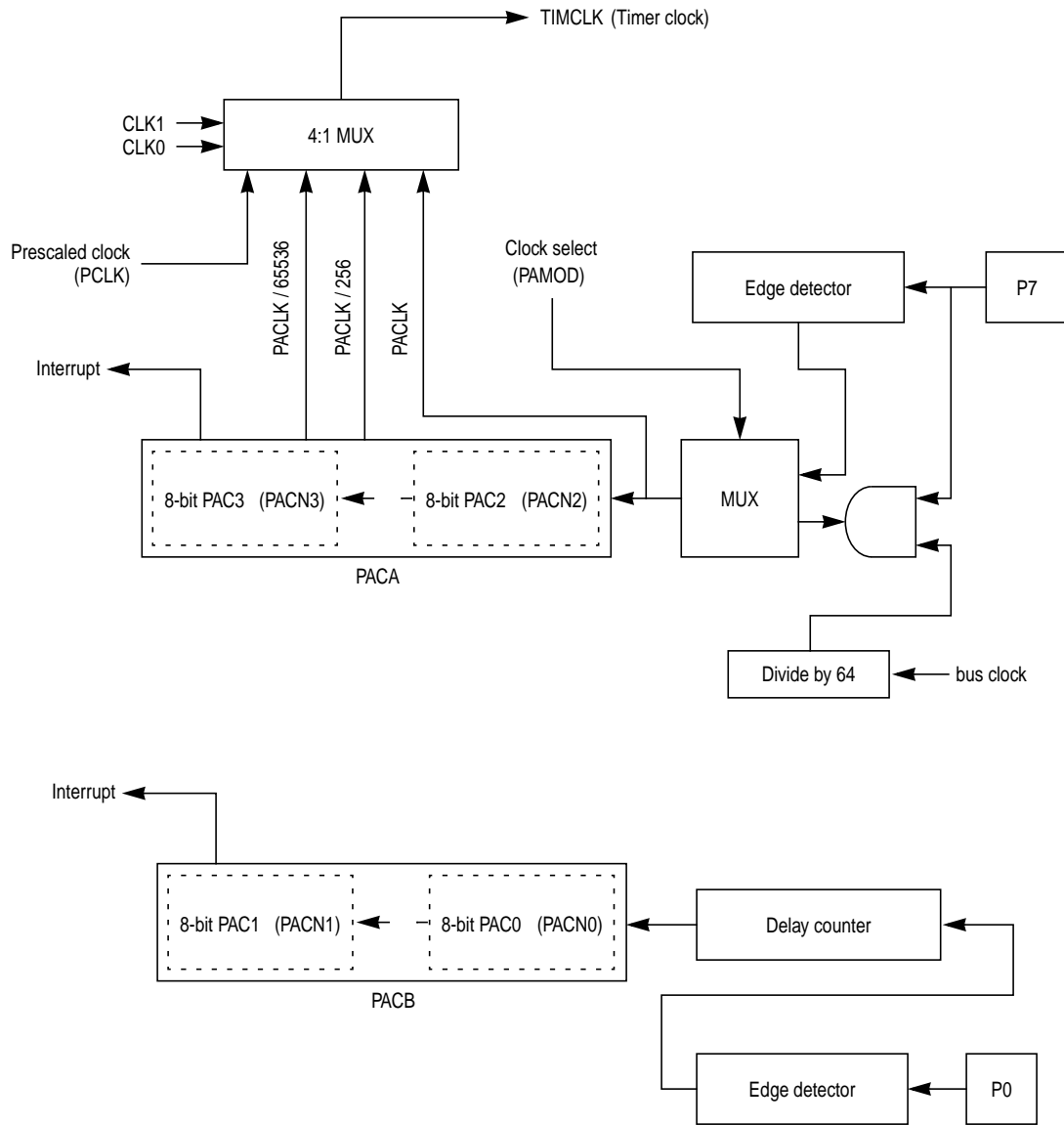
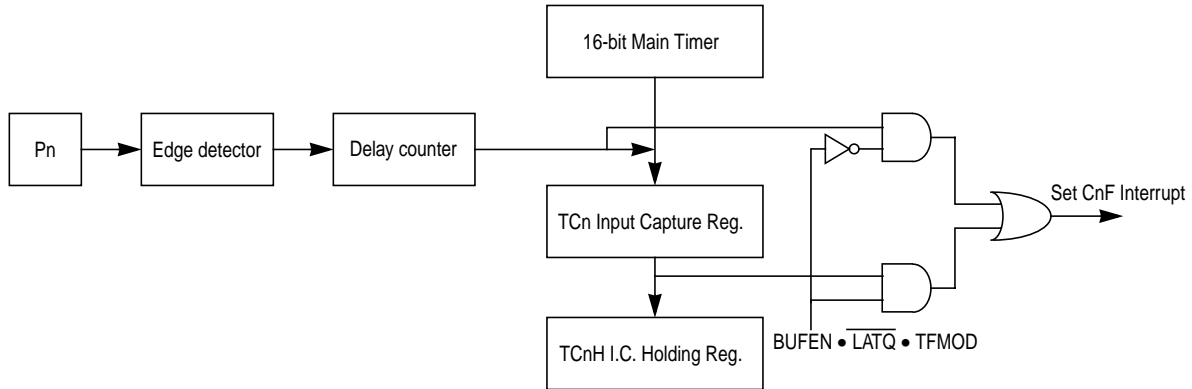

Figure 4-5 Block Diagram for Port7 with Output compare/Pulse Accumulator A



4.2 Enhanced Capture Timer Modes of Operation

The Enhanced Capture Timer has 8 Input Capture, Output Compare (IC/OC) channels same as on the HC12 standard timer (timer channels TC0 to TC7). When channels are selected as input capture by selecting the IOSn bit in TIOS register, they are called Input Capture (IC) channels.

Four IC channels are the same as on the standard timer with one capture register each which memorizes the timer value captured by an action on the associated input pin.

Four other IC channels, in addition to the capture register, have also one buffer each called holding register. This permits to memorize two different timer values without generation of any interrupt.

Four 8-bit pulse accumulators are associated with the four buffered IC channels. Each pulse accumulator has a holding register to memorize their value by an action on its external input. Each pair of pulse accumulators can be used as a 16-bit pulse accumulator.

The 16-bit modulus down-counter can control the transfer of the IC registers contents and the pulse accumulators to the respective holding registers for a given period, every time the count reaches zero.

The modulus down-counter can also be used as a stand-alone time base with periodic interrupt capability.

4.2.1 IC Channels

The IC channels are composed of four standard IC registers and four buffered IC channels.

An **IC register** is **empty** when it has been read or latched into the holding register.

A **holding register** is **empty** when it has been read.

4.2.1.1 Non-Buffered IC Channels

The main timer value is memorized in the IC register by a valid input pin transition. If the corresponding NOVW_x bit of the ICOVW register is cleared, with a new occurrence of a capture, the contents of IC register are overwritten by the new value.

If the corresponding NOVW_x bit of the ICOVW register is set, the capture register cannot be written unless it is empty.

This will prevent the captured value to be overwritten until it is read.

4.2.1.2 Buffered IC Channels

There are two modes of operations for the buffered IC channels.

- IC Latch Mode:

When enabled (LATQ=1), the main timer value is memorized in the IC register by a valid input pin transition. See **Figure 4-1**

The value of the buffered IC register is latched to its holding register by the Modulus counter for a given period when the count reaches zero, by a write \$0000 to the modulus counter or by a write to ICLAT in the MCCTL register.

If the corresponding NOVW_n bit of the ICOVW register is cleared, with a new occurrence of a capture, the contents of IC register are overwritten by the new value. In case of latching, the contents of its holding register are overwritten.

If the corresponding NOVW_n bit of the ICOVW register is set, the capture register or its holding register cannot be written by an event unless they are empty (see **4.2.1**). This will prevent the captured value to be overwritten until it is read or latched in the holding register.

- IC queue mode:

When enabled (LATQ=0), the main timer value is memorized in the IC register by a valid input pin transition. See **Figure 4-2**

If the corresponding NOVW_n bit of the ICOVW register is cleared, with a new occurrence of a capture, the value of the IC register will be transferred to its holding register and the IC register memorizes the new timer value.

If the corresponding NOVW_n bit of the ICOVW register is set, the capture register or its holding register cannot be written by an event unless they are empty (see **4.2.1**).

In queue mode, reads of holding register will latch the corresponding pulse accumulator value to its holding register.

4.2.1.3 Delayed IC channels

There are four delay counters in this module associated with IC channels 0 - 3. The use of this feature is

explained in the diagram and notes below.

Figure 4-6 Channel Input validity with delay counter feature

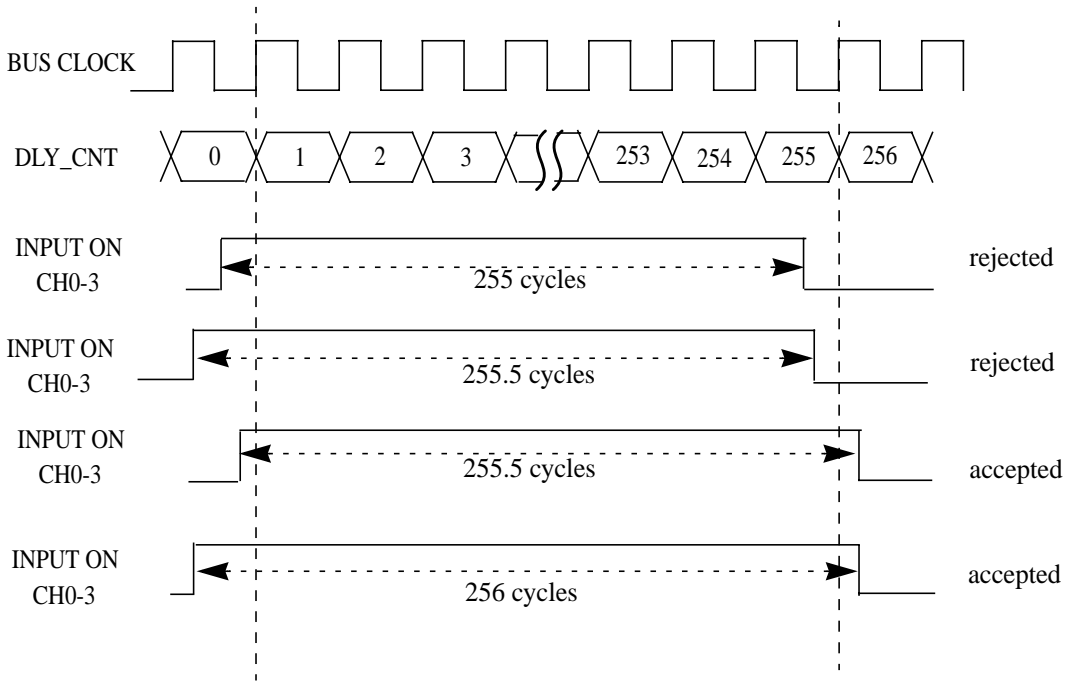

In the diagram above a delay counter value of 256 bus cycles is considered.

1. Input pulses with a duration of $(DLY_CNT - 1)$ cycles or shorter are rejected.
2. Input pulses with a duration between $(DLY_CNT - 1)$ and DLY_CNT cycles may be rejected or accepted, depending on their relative alignment with the sample points.
3. Input pulses with a duration between $(DLY_CNT - 1)$ and DLY_CNT cycles may be rejected or accepted, depending on their relative alignment with the sample points.
4. Input pulses with a duration of DLY_CNT or longer are accepted.

4.2.2 Pulse Accumulators

There are four 8-bit pulse accumulators with four 8-bit holding registers associated with the four IC buffered channels. A pulse accumulator counts the number of active edges at the input of its channel.

The user can prevent 8-bit pulse accumulators counting further than \$FF by PACMX control bit in ICSYS (\$2B). In this case a value of \$FF means that 255 counts or more have occurred.

Each pair of pulse accumulators can be used as a 16-bit pulse accumulator. See **Figure 4-4**

There are two modes of operation for the pulse accumulators.

4.2.2.1 Pulse Accumulator latch mode

The value of the pulse accumulator is transferred to its holding register when the modulus down-counter reaches zero, a write \$0000 to the modulus counter or when the force latch control bit ICLAT is written.

At the same time the pulse accumulator is cleared.

4.2.2.2 Pulse Accumulator queue mode

When queue mode is enabled, reads of an input capture holding register will transfer the contents of the associated pulse accumulator to its holding register.

At the same time the pulse accumulator is cleared.

4.2.3 Modulus Down-Counter

The modulus down-counter can be used as a time base to generate a periodic interrupt. It can also be used to latch the values of the IC registers and the pulse accumulators to their holding registers.

The action of latching can be programmed to be periodic or only once.

4.2.4 Channel Configurations

Timer Channels can be configured as input capture channels or output compare channels. Following are the ways a port can be configured as an output for OC.

The pin associated with channel 7 becomes output-tied to OC7 when

- TEN = 1, IOS7 = 1, and either or both of OM7 and OL7 are set. or
- OC7M7 = 1 and IOS7 = 1.

When masking, the timer does not have to be enabled so that the pin associated with OCn becomes an output tied to OCn.

The pins associated with channels 0-6 become output-tied to OCn (n=0..6) when

- TEN = 1, IOSn = 1, and either or both of OMn and OLn are set or
- OC7Mn = 1, IOS7 = 1 and IOSn = 1

Once the pin is configured as OC, its initial state is zero and its status is changed (if needed) on consecutive clock cycles following the write which enabled the ECT to drive the pin. In other words after a pin starts to be driven by ECT OC logic, it is forced low for at least one clock cycle.

Section 5 Reset

5.1 General

The reset state of each individual bit is listed within the Register Description section (**Section 3 Memory Map and Registers**) which details the registers and their bit-fields.

Freescale Semiconductor, Inc.

Section 6 Interrupts

6.1 General

This section describes interrupts originated by the ECT_16B8C block. The MCU must service the interrupt requests. **Table 6-1** lists the interrupts generated by the ECT to communicate with the MCU.

Table 6-1 ECT Interrupts

Interrupt Source	Description
Timer Channel 7-0	Active high timer channel interrupts 7-0
Modulus counter underflow	Active high modulus counter interrupt
Pulse Accumulator B Overflow	Active high pulse accumulator B interrupt
Pulse Accumulator A Input	Active high pulse accumulator A input interrupt
Pulse Accumulator A Overflow	Pulse accumulator overflow interrupt
Timer Overflow	Timer Overflow interrupt

6.2 Description of Interrupt Operation

The ECT_16B8C only originates interrupt requests. The following is a description of how the module makes a request and how the MCU should acknowledge that request. The interrupt vector offset and interrupt number are chip dependent.

6.2.1 Channel [7:0] Interrupt

This active high output will be asserted by the module to request a timer channel 7 - 0 interrupt to be serviced by the system controller.

6.2.2 Modulus Counter Interrupt

This active high output will be asserted by the module to request a modulus counter underflow interrupt to be serviced by the system controller.

6.2.3 Pulse Accumulator B Overflow Interrupt)

This active high output will be asserted by the module to request a timer pulse accumulator B overflow interrupt to be serviced by the system controller.

6.2.4 Pulse Accumulator A Input Interrupt

This active high output will be asserted by the module to request a timer pulse accumulator A input interrupt to be serviced by the system controller.

6.2.5 Pulse Accumulator A Overflow Interrupt

This active high output will be asserted by the module to request a timer pulse accumulator A overflow interrupt to be serviced by the system controller.

6.2.6 Timer Overflow Interrupt

This active high output will be asserted by the module to request a timer overflow interrupt to be serviced by the system controller.

User Guide End Sheet

Freescale Semiconductor, Inc.

**FINAL PAGE OF
60
PAGES**